

Title		
T2_V1.6		
Size	Document Number	Rev
A	POWER	V1.6
Date:	Thursday, March 12, 2020	Sheet 1 of 2

### USB

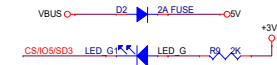

### UART

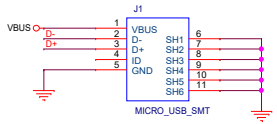
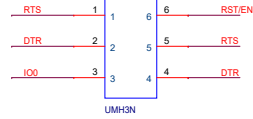
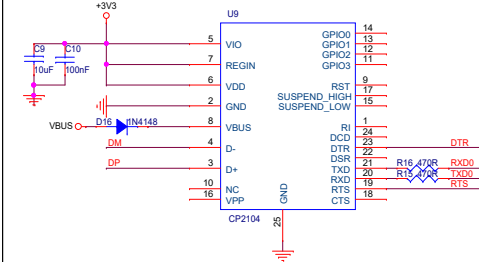

### 5V-3.3V

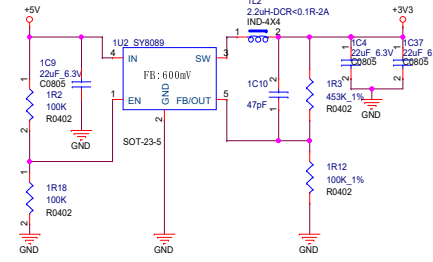

### VCC

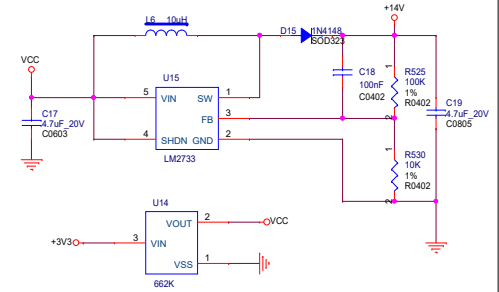

### Core

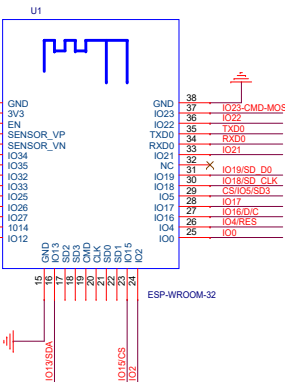
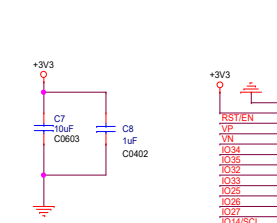

### Connector

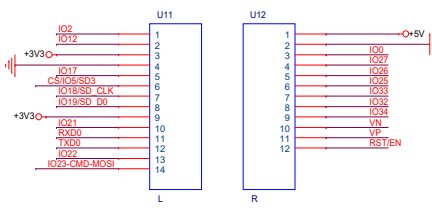

### LCD

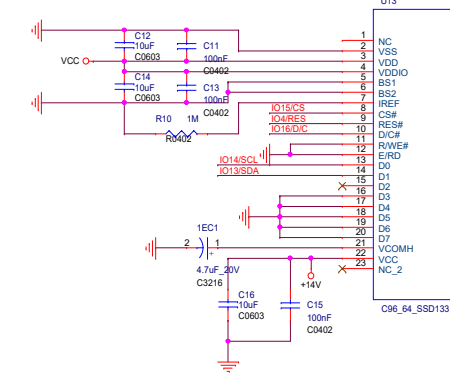

### SD CARD

